



INGO FISCHER

GRAFIKDESIGN, ART DIREKTION & ILLUSTRATION

AUSGEWÄHLTE ARBEITEN



I WORK, BECAUSE I LOVE WHAT I DO.

Mein Name ist Ingo Fischer, Grafikdesigner, Art Direktor und Illustrator mit mittlerweile mehr als 20 Jahren Berufserfahrung. Die Gestaltung von Skateboards und T-Shirt Motiven für Punk-Bands machten damals den Anfang für den beruflichen Werdegang, der über verschiedene Agenturen und Verlagen in die Selbstständigkeit führte.

Mit einem multidisziplinären Ansatz, Herzblut und Liebe zum Detail realisiere ich verschiedenste Projekte von der Markengestaltung bis hin zum analogen Musikartwork mit dazugehöriger digitaler Social Media Kampagne.

Ich freue mich auf neue Herausforderungen!

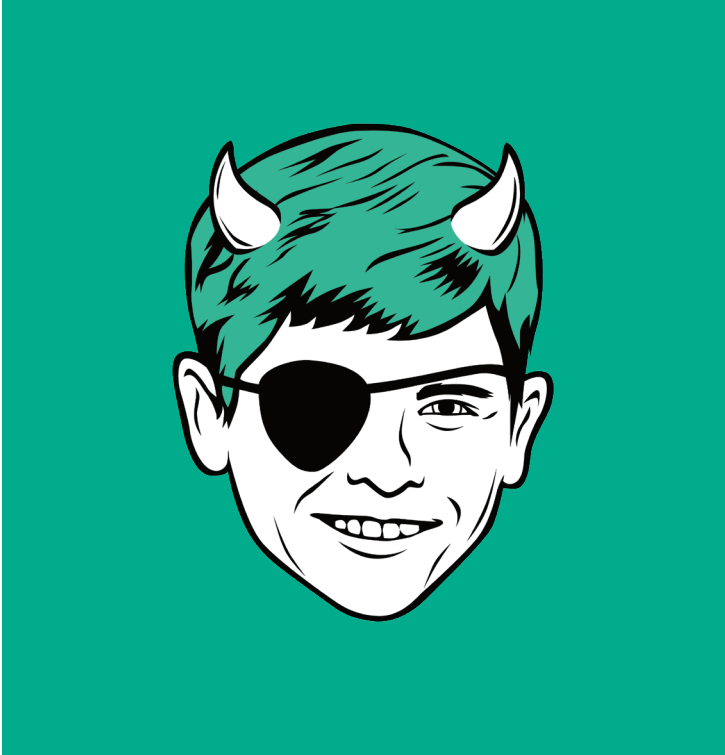

STATIONEN

2002 Junior Art Direktor, König+Engländer Kommunikations Agentur, Hamburg

2004 Art Direktor, König+Engländer Kommunikations Agentur, Hamburg

2006 Freelancer für verschiedene Agenturen & Kunden

2013 Art Direktor, Dialog GmbH, Dortmund

2018 Senior Art Direktor, Rocket & Wink, Hamburg

2020 Freelancer für verschiedene Agenturen & Kunden

KUNDEN & AGENTUREN

Universal Music, Sony BMG, Audiolith, Fritz Kola, FC St. Pauli, Visions Magazin, Mint Magazin, Heyne Verlag, Greenception, Mob Skateboards, Merchcowboy, HSV, Sportfive, Veltins V+, Montblanc, StageEntertainment, Neue Monarchie, Peter Arndt Werbeagentur, Headcharge, Vesch, Donkey, Rocket & Wink, JKP Jochens Kleine Plattenfirma

KONTAKT

Kampstraße 24
20357 Hamburg

0176.499 069 52
ingo@artfart.de

artfart.de
behance.net/fartboy
instagram.com/artfart.de



DSC Arminia Bielefeld
Corporate Design 2020
Agentur: Rocket & Wink

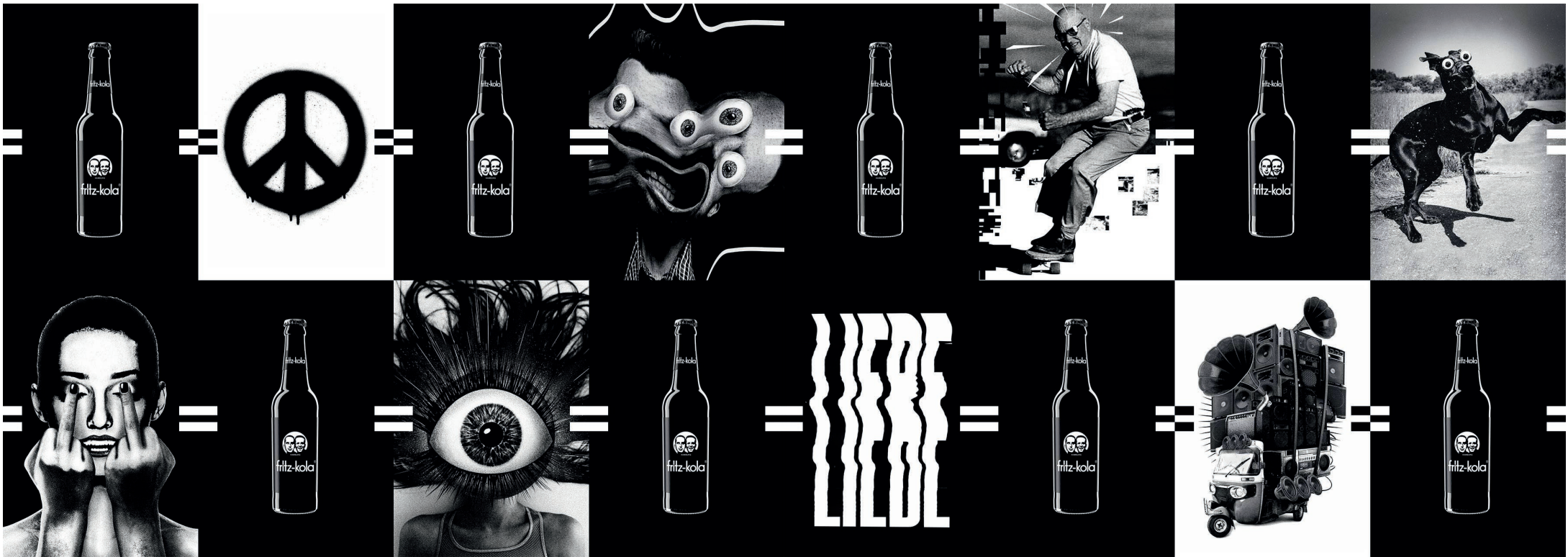

fritz kola
 "ist gleich"-Kampagne 2019
 Gestaltung der Visuals und Werbemittel
 Agentur: Rocket & Wink



Greenception
SMART BIOENGINEERING

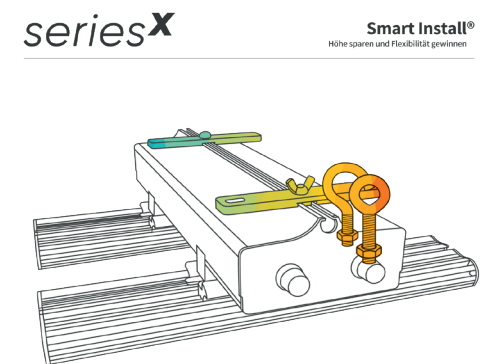
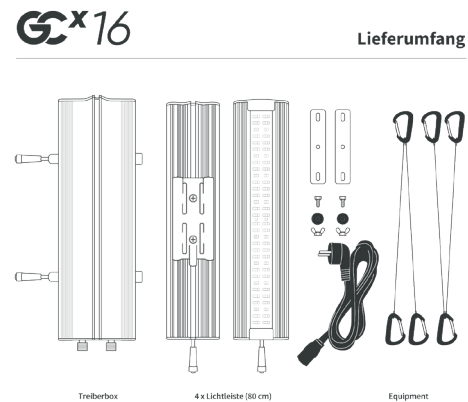
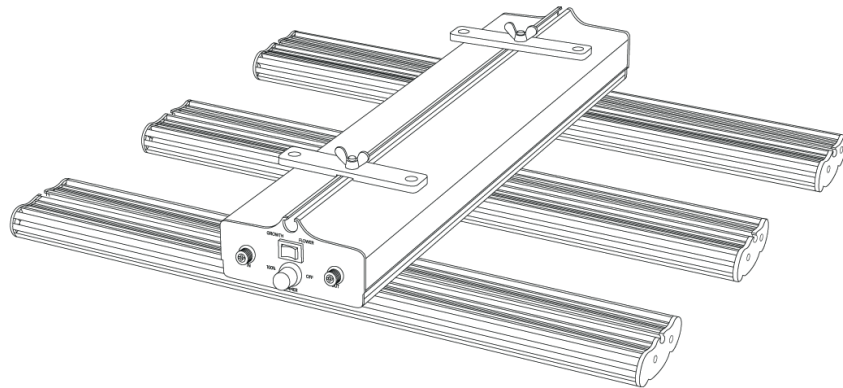
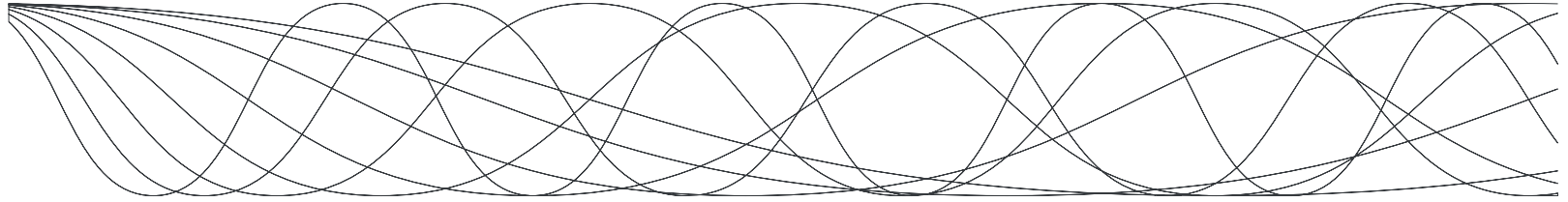
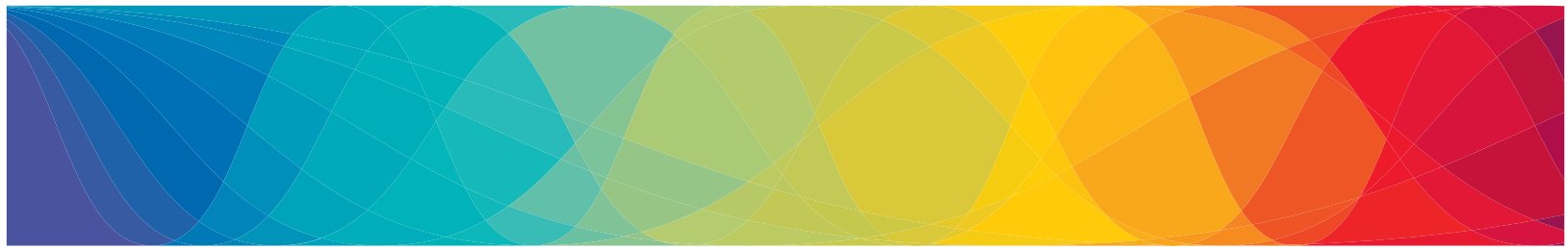



Fatoni
Wunderbare Welt
LP / CD Artwork



Fatoni
Digital Singles

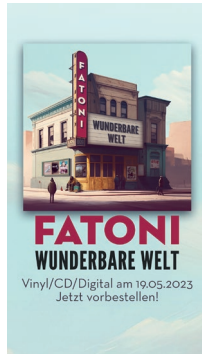

Social Media Formate
Tour und Album Promotion
Merchandise



Neonschwarz

Morgengrauen

LP / CD Artwork

Gestaltung des Albums "Morgengrauen" 2021



Neonschwarz Digital Singles



Neonschwarz
Merchandise



Neonschwarz
Diverse Online-Werbemittel

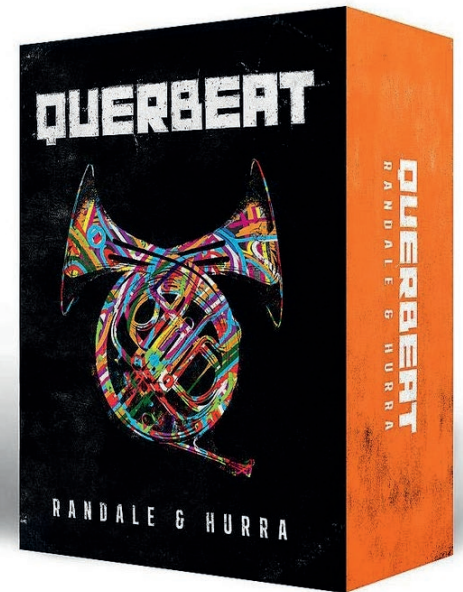
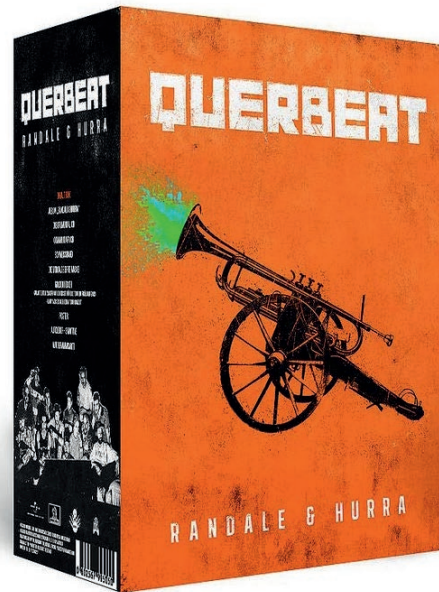

Querbeat
Randalé & Sturm
LP, CD Artwork und Specialbox mit Poster und Autogrammkarte

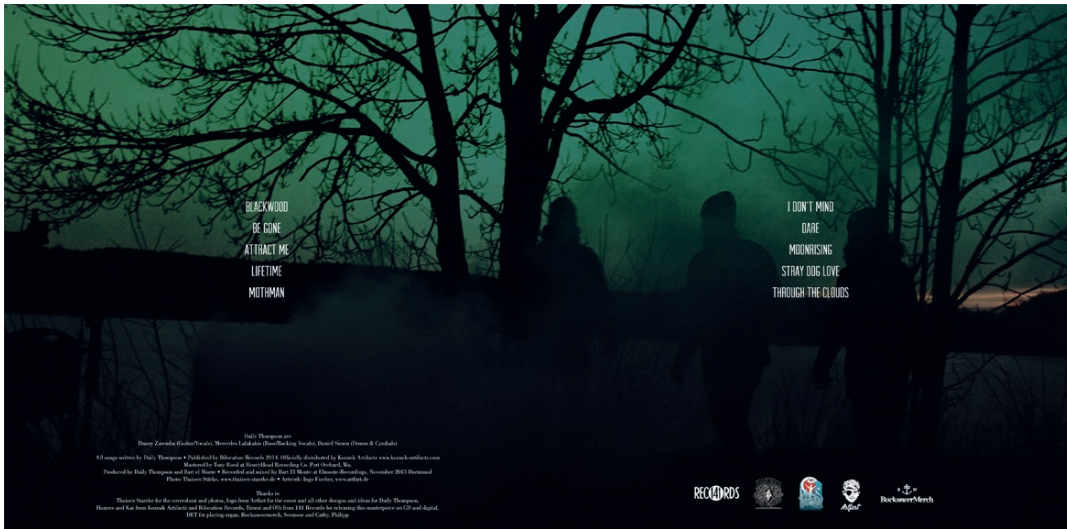

Daily Thompson

s/t

LP Gatefold Artwork

Feine Sahne Fischfilet präsentiert:

WASTED IN JARMEN

FESTIVAL



08. & 09. SEPTEMBER 2023
Motoballplatz Jarmen

WASTEDINJARMEN.DE | VERANSTALTER: HINTERLANDKULTUR E.V.

TRUE-REBEL



NOCH
KEIN
KOMPLETT
IM JARMEN

GRÜNE
ROCK
CAMP



WASTED IN JARMEN

FESTIVAL

08. & 09. SEPTEMBER 2023
Motoballplatz Jarmen



FEINE SAHNE FISCHFILET BROILERS
ALEX MOFA GANG BROCKHOFF PANTEON ROCCOCO
DEINE COUSINE HINTERLANDGANG ANTITRANSPIRANTI
TORFHEADS ATTIC 109 QUEENS OF EVERYTHING SHOW OFF FREAKS
FEMDELIC BANDA COMUNALE SIEBENMORGEN SOS RAP GIRLS DIE KERZEN
BANDCONTEST REXI TURNER BOOGIEMEYER SOUND DJ AUSBRUCH
ARSCHBOMBENCONTEST BIBEROLYMPIADE VORTRÄGE LESUNGEN THEATER FILME FUSSBALLSPIEL

08. & 09. SEPTEMBER 2023 wastedinjarmen.de



Wasted in Jarmen
2023, Festival
Gestaltung des Visuals, Bühne und Werbemittel

Feine Sahne Fischfilet präsentiert.

WASTED IN JARMEN FESTIVAL



30. & 31. AUGUST 2019
MOTOBALLPLATZ · JARMEN / DEMMINER STRASSE



TRUE-REBEL

WWW.WASTEDINJARMEN.DE
Veranstalter: Hinterhandkultur o.V.i.G



NOCH NICHT KOMPLETT IM ARSCH



Wasted in Jarmen
2019, Festival
Gestaltung des Visuals, Bühne und Werbemittel

Feine Sahne Fischfilet präsentiert:

WASTED IN JARMEN

OPEN AIR

..... Samstag

04.AUGUST 2018

JARMEN

.....

WWW.WASTEDINJARMEN.DE

WOCH
NICHT
KOMPLETT
IM ARSCH

TRUE REBEL

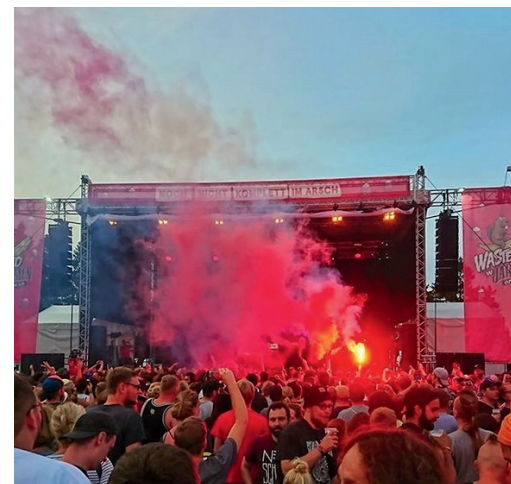

Wasted in Jarmen
2018, Festival
Gestaltung des Visuals, Bühne und Werbemittel

STOUT IPA BEER LAGER

Small BATCH (KLEINSERIE)

C[CH](O)C

Yeah!

Yeah!

NOLTE

Name:

Braudatum:

Gebräut mit  UND DEN BESTEN ZUTATEN

NOLTE
BRAUHAUS NOLTE SEIT 1906
Lineburg

N

Yeah!

Yeah!

NOLTE

BRAUHAUS
seit 1906



Brauhaus Nolte
Label für "Small-Batch" Serie





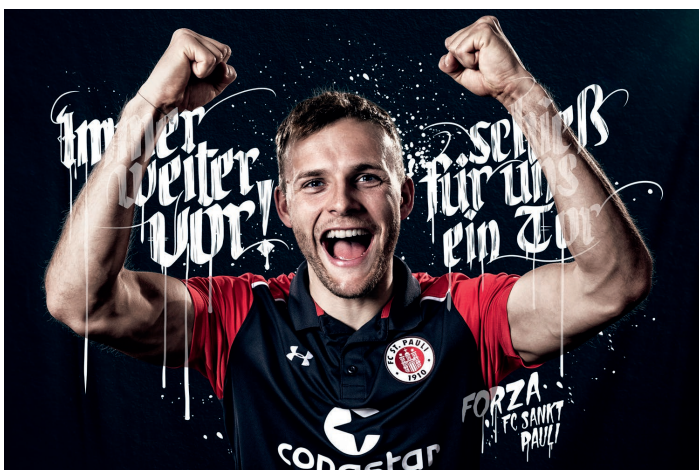
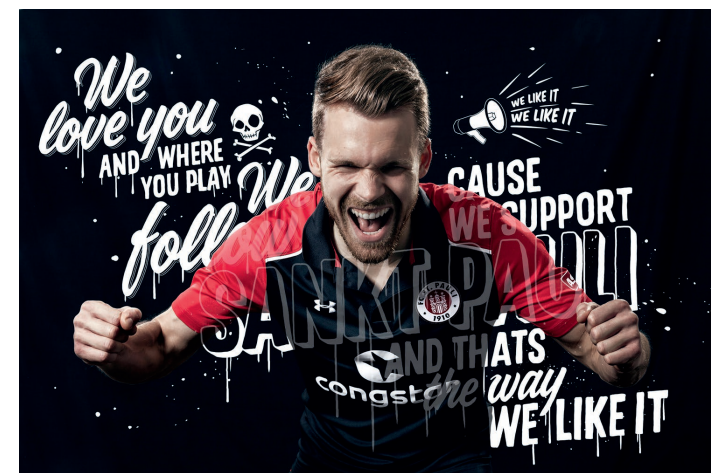



Thick as Thiefs
Ankündigungsplakat, A0, Art Direktion



Klubsen
Veranstaltungsplakat, A0, Art Direktion

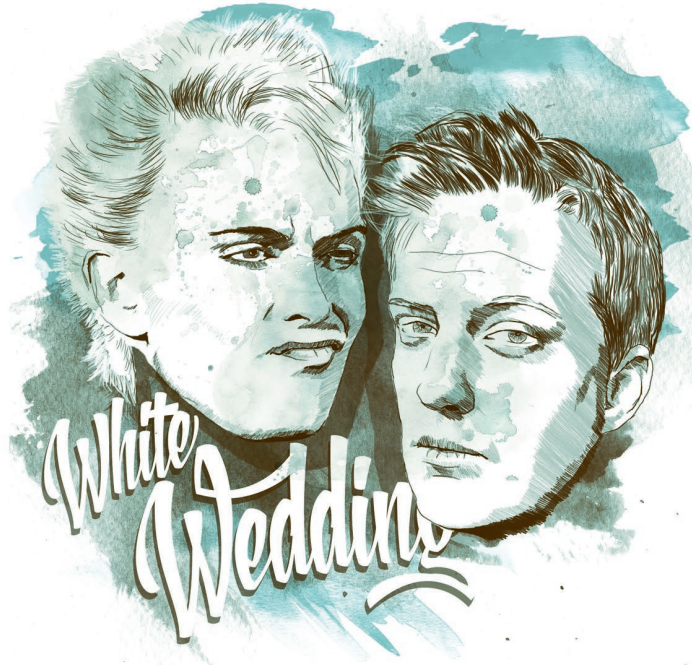



Elfen, Trolle, Sensationen - Island Music Export
Editorial Illustration, VISIONS Magazin



Best of 2014
Cover Illustration, VISIONS Magazin

WASTED
IN JARMEN
OPEN AIR

STOP
BEING
PERFECT

PANICBURG
CITY

Sunset Tacos

SIGNS *with* SOULS
• TRADITIONELLE SCHILDERMALEREI •

Scott
Rocket

Cpt. Pee
Wards

LEADER
of the
PACK

GALORE
BOOKSTORE KEEPER

CANNABIS
Blog

Neponuk

Girl
SCOUT
Cookies
DURBAN POISEN x OG KUSH

THE
VARANES



STAND
UP!

HAIL
Mary

TANZ
FLÄSCH





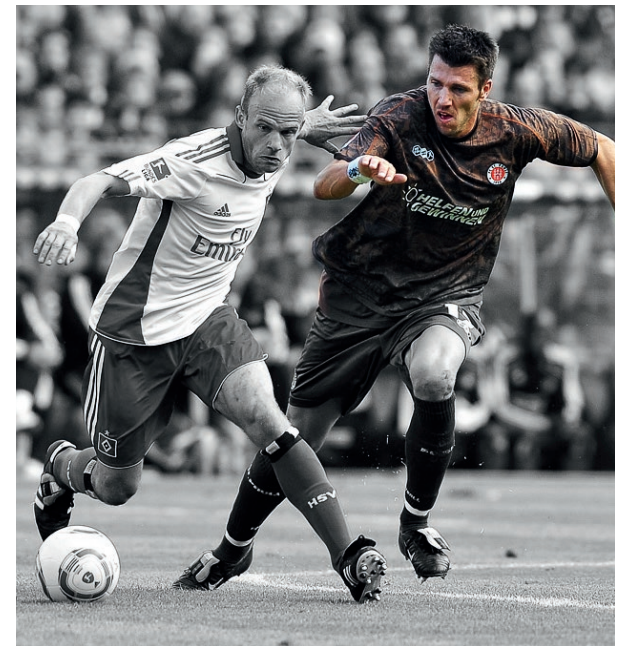

Foto mit freundlicher Genehmigung von Stefan Groeneweld

DANKE FÜR IHRE
AUFMERKSAMKEIT!